

SERVICE BULLETIN



Service Department . . . Chrysler and Imperial Division
CHRYSLER CORPORATION

Information for Service Mgr. Shop Foreman Parts Mgr. Technicians

TO ALL CHRYSLER AND IMPERIAL DEALERS:

The enclosed bulletin covers the data and specifications of the 1960 Chrysler C300-F.

The information contained in this bulletin supplements the general service information in the 1960 Chrysler and Imperial Service Manual. This information covers in detail the specific data and specifications of the 1960 Chrysler C300-F engine and in particular the two 4-barrel carburetors, full race camshaft, special ram induction intake manifold, low restriction air cleaners, heavy duty valve springs and dampers, as well as other features exclusive with the 1960 Chrysler C300-F.

C. T. McClure

C. T. McCLURE
Director of Service
CHRYSLER AND IMPERIAL DIVISION

Feb. 25, 1960

No. 60-30

MISCEL-
LANEOUS

DATA AND
SPECIFICA-
TIONS

CHRYSLER
ALL 1960
C300-F
MODELS

P-710

IMPORTANT: This bulletin contains valuable information and was prepared at considerable expense to be of service to you. Failure to use this information may cost you good will and money. We suggest that you insure it is read by all those concerned, and then filed for future reference in your Service Bulletin binder.

CONTENTS

<u>Group</u>	<u>Title</u>	<u>Page</u>
0	Lubrication	3
1	Accessories (Radios and Heaters)	3
2	Front Suspension	3
3	Rear Axle	3
4	Parking Brakes	4
5	Service Brakes	4
7	Cooling System	4
7A	Accessory Belt Drives	4
8	Electrical System	4
9	Engine	5
10	Engine Oiling System	8
11	Exhaust System	8
13	Frame	8
14	Fuel System	8
16	Universal Joints and Propeller Shaft	23
17	Springs and Shock Absorbers	23
19	Steering	23
21	Transmission	23
22	Wheels and Tires	27
23	Body and Sheet Metal	27
24	Air Conditioning	28

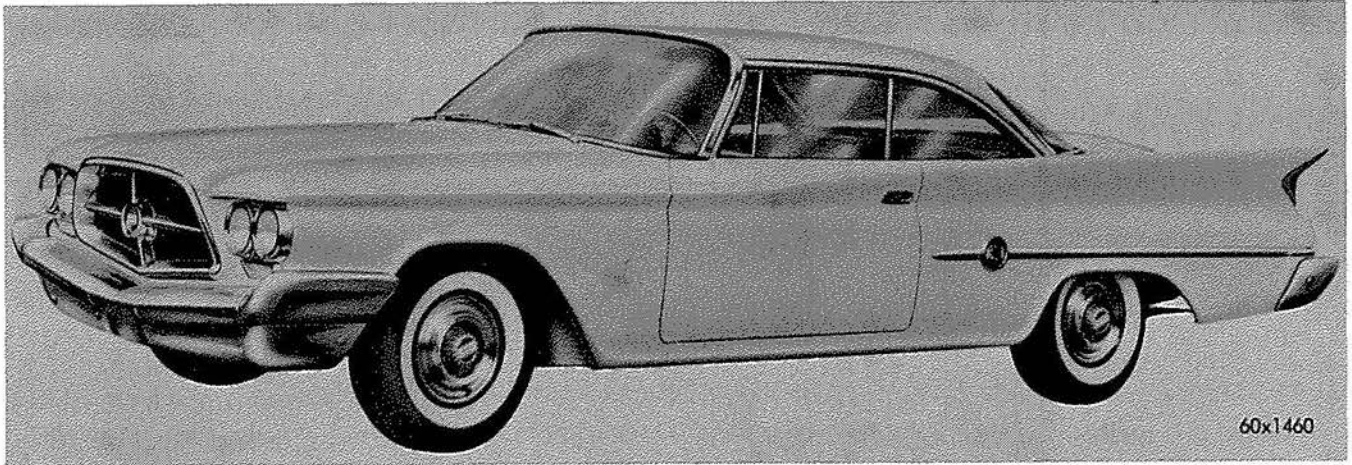

C-300 F Sport Coupe

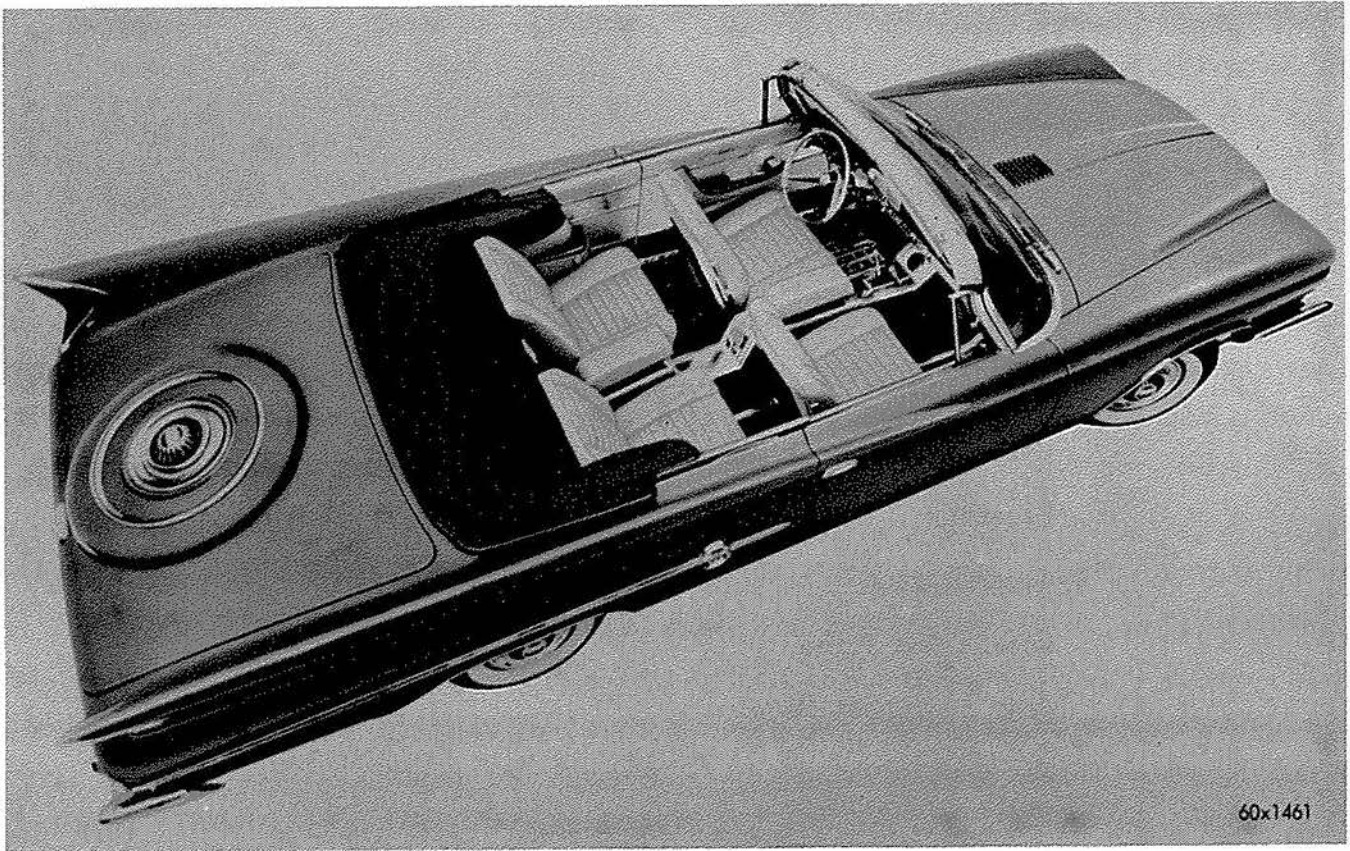

Fig. 1 Two Door Hardtop and Sport Convertible with Individual Seating

1960 CHRYSLER - 300-F

GENERAL DATA AND SPECIFICATIONS

<u>ITEM</u>	<u>FIGURE - 1</u>	<u>BODY STYLE</u>
<u>Sports Coupe Two-Door Hardtop and Convertible Coupe</u>		
Wheelbase		126 inches
Tread (Front)		61.2 inches
Tread (Rear)		60.0 inches
Length with Bumper		219.62 inches
Width with Bumper		79.44 inches
Height		55.2 inches
Rear Axle Ratio		3.31:1
Tire Size		9.00 x 14

Group 0 - LUBRICATION

All Lubrication is the same as used on Model PC-3. Refer to the 1960 Chrysler and Imperial Service Manual, Group 0 - Lubrication.

Group 1 - ACCESSORIES (RADIOS AND HEATERS)

The Radio and Heater Models are identical with those used on the PC-3. For service procedures, refer to the 1960 Chrysler and Imperial Service Manual.

Group 2 - FRONT SUSPENSION

The Front Wheel Suspension System is of the same basic design used in Model PC-3, with the following changes:

FRONT SUSPENSION HEIGHT

The difference in the height between the floor and the measuring points on each lower control arm (lowest point on ball joint housing and underside of bushing housing between the flanges of arm) should be 1 3/4 inches. This height must be maintained \pm or - 1/8 inch with the maximum differential from the right to the left of 1/8 inch.

Group 3 - REAR AXLE

The Rear Axle is of the same basic design as used on the Model PC-3. Standard and "Sure-Grip" axle ratio is 3.31, (43-13). For servicing, refer to the Rear Axle Group 3 of the 1960 Chrysler and Imperial Service Manual.

Group 4 - PARKING BRAKE

The Parking Brake is of the same design as used on Model PC-3. For servicing procedures, refer to the Parking Brake Group 4 in the 1960 Chrysler and Imperial Service Manual.

Group 5 - SERVICE BRAKES

The Brake System is of the same basic design as used on Model PC-3. The power brake is a special Bendix unit with a modified housing to control routing of the intake manifold vacuum hose to the unit, and eliminate interference at the carburetor. For servicing the brakes, refer to the Brake Group 5 of the 1960 Chrysler and Imperial Service Manual.

Group 7 - COOLING SYSTEM

The Cooling System is the same design as used on Model PC-3 except the Silent Flite Fan Drive, which is standard equipment. A box shroud is used on cars equipped with Air Conditioning.

Adjust the carburetor for proper idle as indicated in the Fuel System Group to obtain satisfactory idle cooling. For servicing, refer to the Cooling System of the 1960 Chrysler and Imperial Service Manual.

	<u>Fan Diameter</u>	<u>Number Blades</u>	<u>Shaft Painted</u>
Without Air Conditioning	18"	7	Black
With Air Conditioning	18 1/2"	7	Aluminum

Group 7A - ACCESSORY BELT DRIVES

The belt deflections remain the same as outlined in Accessory Belt Drives, Group 7A, of the 1960 Chrysler and Imperial Service Manual.

Group 8 - ELECTRICAL SYSTEM

Electrical units are identical with those used on Model PC-3 with the exceptions listed in the following specifications:

DISTRIBUTOR

Make	Auto-Lite
Part No.	1BS-4011
Automatic Advance (centrifugal)	0° @ 325 to 475
(Distributor Degrees and R.P.M.)	0° to 4.3° @ 475
	4.5° to 6.5° @ 640
	9° to 11° @ 240

DISTRIBUTOR, (continued)

Vacuum Advance
(Degrees of Inches of Vacuum) 0° @ 7.2" to 8.9"
4.5° to 7.5° @ 12"
7.5° to 10.5° @ 14.5"

Basic Timing

With Torque-Flite Transmission 5° BTC
With 4 Speed Manual 10° BTC

SPARK PLUGS

Type A32 Standard
Auto-Lite A-201 or Champion
J-79 (optional)
Thread Length 3/8 inch
Size 14MM
Gap035 inch

For Service Procedures, refer to the 1960 Chrysler and Imperial Service Manual.

Group 9 - ENGINE - DATA AND SPECIFICATIONS

MAIN BEARINGS

Diametral Clearance (desired)001 to .002 inch

MAIN BEARINGS SIZES

Diametral Clearance (desired) No. 1 2.750 x .914 inch
No. 2 2.750 x .914 inch
No. 3 2.750 x .943 inch
No. 4 2.750 x .914 inch
No. 5 2.750 x .914 inch

TAPPETS

Type Hydraulic
Clearance in Block0005 to .0018 inch
Body Diameter9040 to .9045 inch

VALVES - INTAKE

Lift430 inch

VALVES - EXHAUST

Lift430 inch

VALVE SPRINGS

Number 16
Free Length 2.38 inch
Load when Compressed to (valve closed) 1.860 inch - 92 to 105 lbs.
Load when Compressed to (valve open) 1.43 inch - 197 to 213 lbs.
Valve Springs I.D. 1.070 to 1.090 inch
Valve Spring Installed Height
(Spring Seat to Retainer) 1.830 to 1.890 inch
Recondition at 1.910 inch
Surge Damper Spiral Type

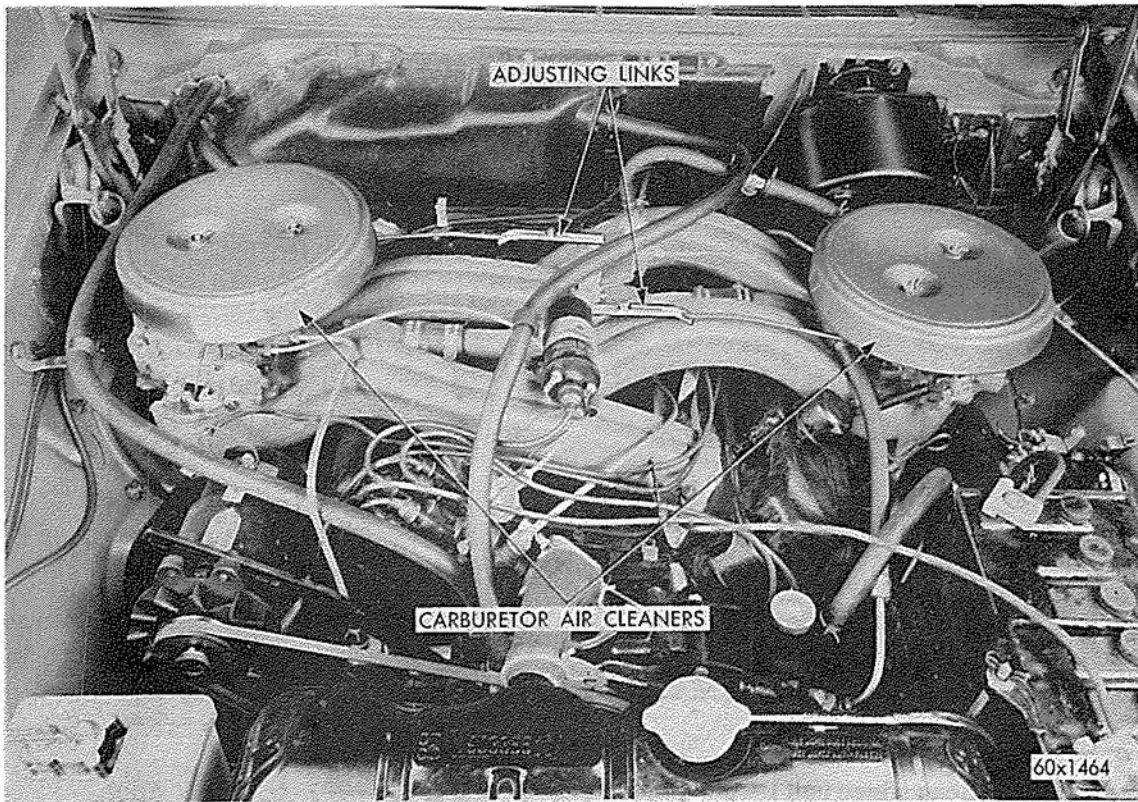

Fig. 2 - Engine Compartment - (Front View)

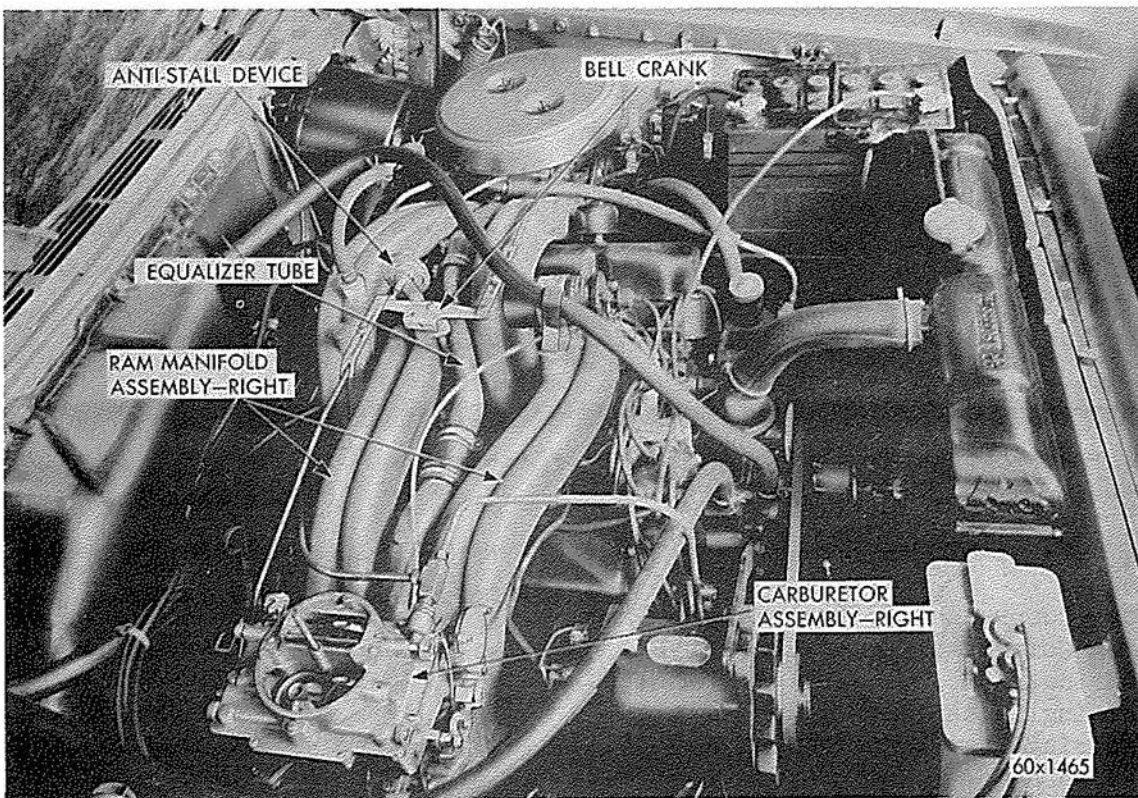

Fig. 3 - Engine Compartment - (Right Side View)

Group 9 - ENGINE - DATA AND SPECIFICATIONS (Continued)

VALVE TIMING

Intake	-	opens	20° BTC
		closes	68° ABC
		duration	268°
Exhaust	-	opens	60° BBC
		closes	28° ATC
		duration	268°
Valve Opening Overlap			48°

The Chrysler 300-F is powered by a new high performance version of the 413 cubic inch engine. The outstanding feature is the new long branch ram induction intake manifolds cast of aluminum. Two four-barrel carburetors and new dual air cleaners are used, as shown in Figures 2, 3 and 4.

The engines uses the high load valve springs and spiral type surge dampers.

Engine Idle Setting

Set the idle adjustment to obtain a smooth idle at 725-750 rpm, as outlined in the Fuel Group of the 1960 Chrysler and Imperial Service Manual.

Ignition Timing

Disconnect distributor vacuum line, set ignition at 5 degrees BTDC and reset engine idle back to 725-750 rpm if necessary.

Valve Timing Procedure

(1) Check the accuracy of the TDC mark on the pulley (vibration damper) by bringing the number one piston to top dead center.

(2) Rotate the crankshaft until #6 exhaust valve is closing and #6 intake valve is opening.

(3) Install a dial indicator on #1 intake valve so that the indicator pointer contacts the retainer as near to a 90° angle as possible.

(4) Insert a 1/4 inch spacer between the rocker arm and the stem of #1 intake valve (second valve from the front on the left bank). Allow the spring load to bleed the tappet down giving in effect a solid tappet. Adjust the dial indicator to zero.

(5) Turn the crankshaft clockwise (normal running direction) until the valve has lifted .034 inch. The timing of the crankshaft should be now read from 10° BTC to 2° ATC. Turn the crankshaft counterclockwise until the dial indicator is at zero and remove the spacer.

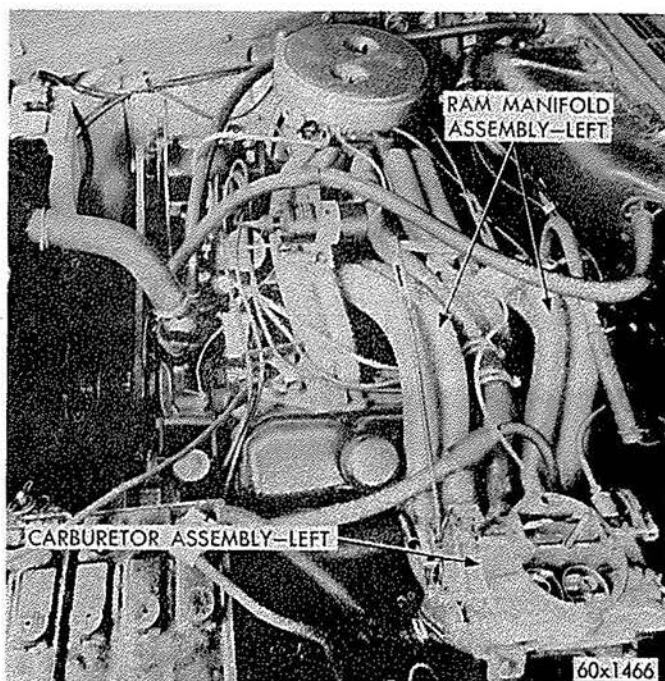

Fig. 4 - Engine Compartment
Left Side View

Group 10 - ENGINE OILING SYSTEM

The Engine Oiling System remains the same as used on Model PC-3. Refer to the 1960 Chrysler and Imperial Service Manual.

Group 11 - EXHAUST SYSTEM

Two manifold heat control valves are used on the C-300-F, as shown in Figure 13.

Larger exhaust pipes with balance pipe, and low restriction mufflers are used on the C-300-F, as shown in Figure 5.

Group 13 - FRAME

The Frame is of the same basic construction as used in the PC-3 Models. For servicing of the frame, refer to Group 13 of the 1960 Chrysler and Imperial Service Manual.

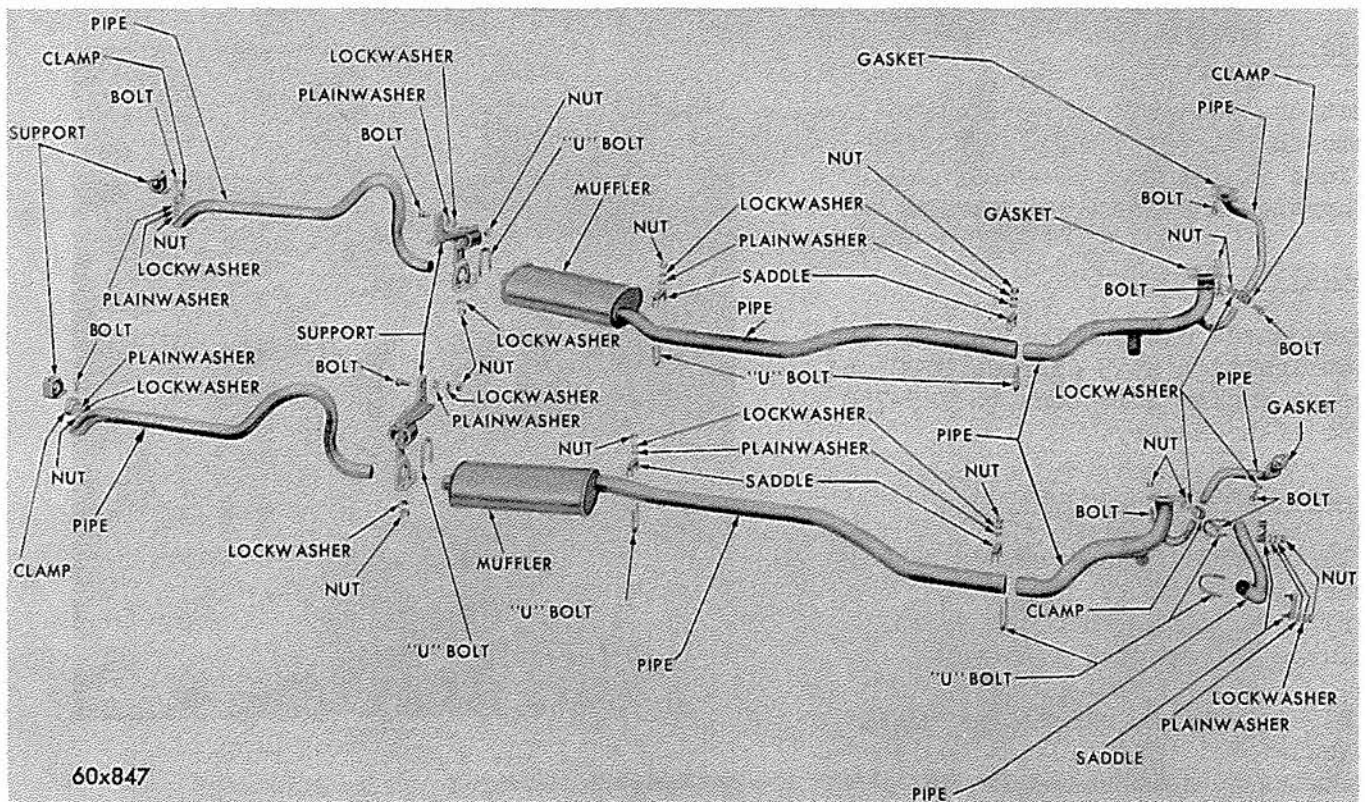

Fig. 5 Ram Manifold Exhaust System

Group 14 - FUEL SYSTEM

Two AFB carburetors are used on the C-300-F.

Data and Specifications, carburetor adjustments, servicing the ram manifold are covered in the following paragraphs.

AFB SERIES CARBURETOR - DATA AND SPECIFICATIONS

CARBURETOR

Type 4 Barrel Downdraft
Model (automatic transmission) AFB-2903S

THROTTLE BORE

Primary 1-7/16"
Secondary 1-11/16"

MAIN VEINURI

Primary 1-3/16"
Secondary 1-9/16"

LOW SPEED JET

Primary No. 65 - .035"

ADJUSTMENTS

Accelerator Pump Setting (top of plunger to
air horn). 7/16"
Choke Unloader (wide open kick) 1/4"
Fast Idle Adjustment010
Fast Idle speed (rpm) ***
Idle Speed Adjustment (rpm) **725 - 750
Secondary Throttle Lever Adjustment 19/64"
Secondary Throttle Lock-out Adjustment020"
Float Setting (gasket to top of floats) 9/32"
Float Drop 3/4"
Idle Mixture (both screws-turns open) 1-2
Automatic Choke Unit Setting 1 Notch Rich

** 725 to 750 rpm and constant with the transmission in neutral (N) and the air conditioning compressor "on" (if so equipped).

*** See procedure for Setting Fast Idle Speed.

SPECIAL TOOLS

C-3400 Repair Stand
T-109-287S Elevating Legs
T-109-22 Bending Tool
T-109-29 Wire Gauge (.020" and .030")
. (Fast Idle)
T-109-31 Gauge 1/4" (Choke Unloader)
T-109-41 Bending Tool (Fast Idle End
Unloader)
T-109-58 Screwdriver Bit
T-109-59 Screwdriver Bit
T-109-106 Float Gauge (7/32")

SPECIAL TOOLS (continued)

T-109-126	Float Gauge (9/32")
T-109-200	Wire Gauge (.010" and .012")
.	Fast Idle
T-109-213	Bending Tool

CARBURETOR ADJUSTMENTS

The following adjustments should be made with the carburetor on the bench for ease of working, and should be made in the following order:

A. Fast Idle Adjustment

(1) With the choke valve held tightly closed and carburetor inverted, tighten the fast idle adjusting screw (on the high step of the fast idle cam) until wire gauge Tool T-109-29 (.020 inch) can be inserted between the primary throttle valve and the bore (side opposite idle port), as shown in Figure 6. The index mark on the fast idle cam should be in direct line with the fast idle screw shank, as shown in Figure 7. The index mark on the cam should be in direct line with the fast idle screw shank.

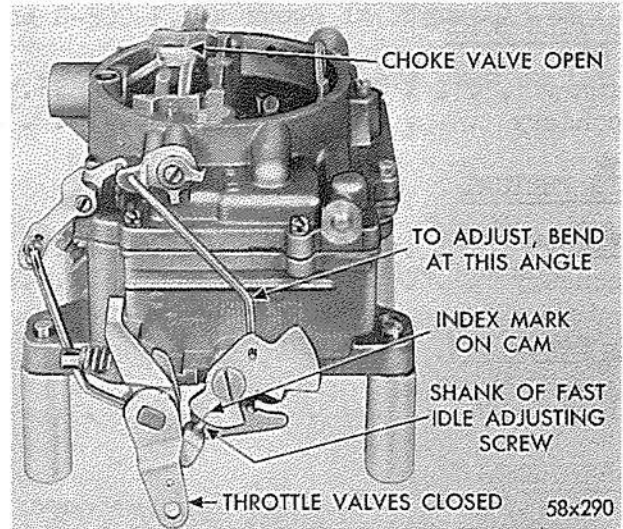

Fig. 7 - Indexing Fast Idle Cam

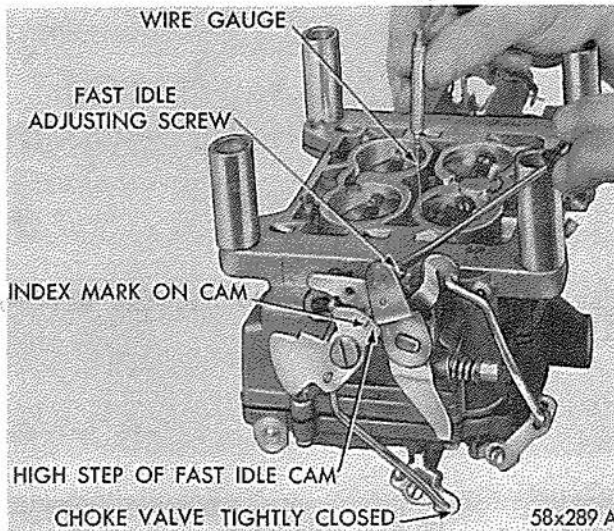

Fig. 6 Checking and Adjusting the Fast Idle

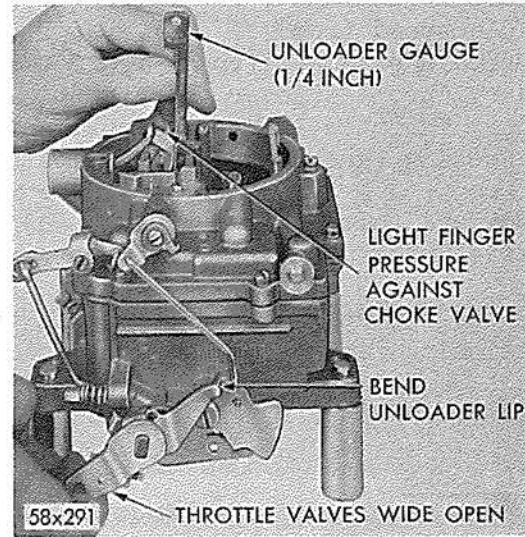

Fig. 8 - Checking and Adjusting Choke Unloader (Fast Idle Kick)

(2) Invert the carburetor and open the throttle valves to wide open position. Close the choke valve tightly and then close the throttle valves. Release the choke valve. This will position the fast idle cam to fast idle. The index mark on the cam should line up with the center of the fast idle adjusting screw, as shown in Figure 7.

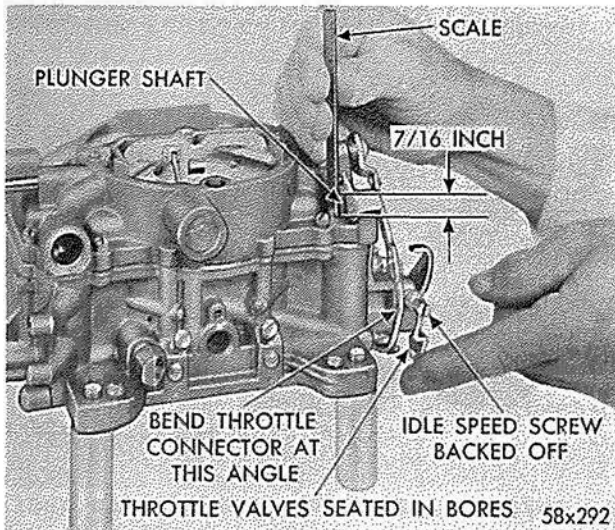

Fig. 9 Checking Accelerator Pump Travel

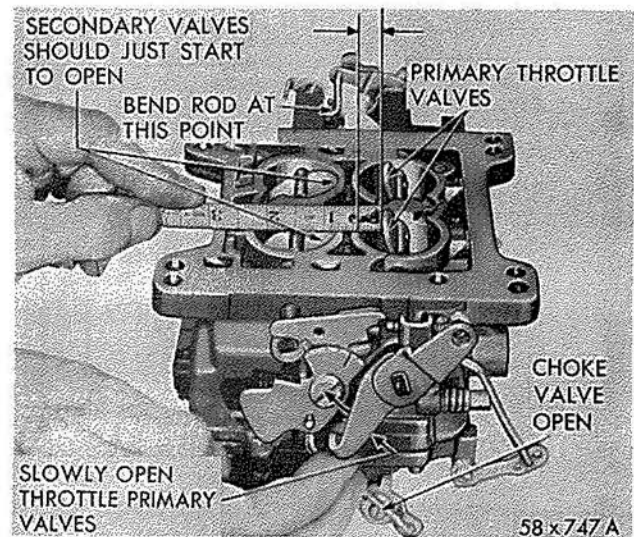

Fig. 10 Checking Secondary Throttle Opening

(3) If an adjustment is necessary, bend the fast idle connector rod at the angle, using Tool T-109-213, until the index mark on the cam indexes the fast idle adjusting screw.

B. Choke Unloader Adjustment

(1) With the throttle valves in the wide open position, it should be possible to insert Tool T-109-31 (1/4 inch) gauge between the upper edge of the choke valve and the inner wall of the air horn, as shown in Figure 8.

(2) If an adjustment is necessary, bend the unloader lip on the throttle shaft lever, using, Tool T-109-41, until correct opening has been obtained.

C. Accelerator Pump Adjustment

(1) Move the choke valve to wide open position, to release the fast idle cam. Back off the idle speed adjusting screw (curb idle) until the throttle valves are seated in the bores.

(2) Measure the distance from the top of the plunger shaft, using a "T" scale, as shown in Figure 9. This distance should be 7/16 inch on AFB 2903S.

(3) If an adjustment is necessary, bend the throttle connector rod at the lower angle, using Tool T-109-213, until correct travel has been obtained.

D. Secondary Throttle Lever Adjustment

(1) To check the secondary throttle lever adjustment, block the choke valve in the wide open position and invert the carburetor.

(2) Slowly open the primary throttle valves until it is possible to measure 19/64 inch between the lower edge of the primary valve and the bore (opposite idle port), as shown in Figure 10. At this point, the secondary valves should just start to open.

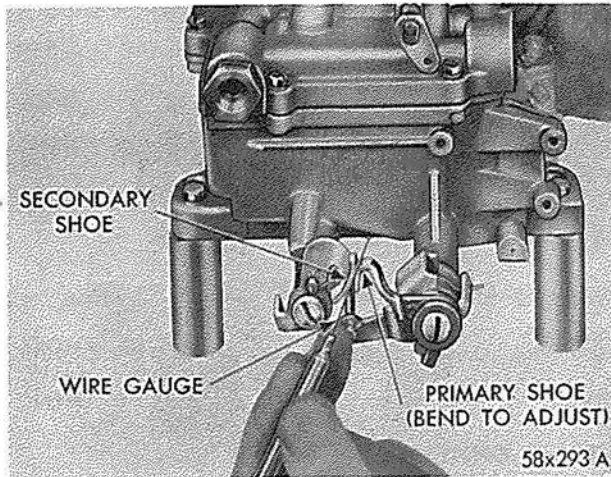

Fig. 11 Determining Clearance Between Primary and Secondary Shoes

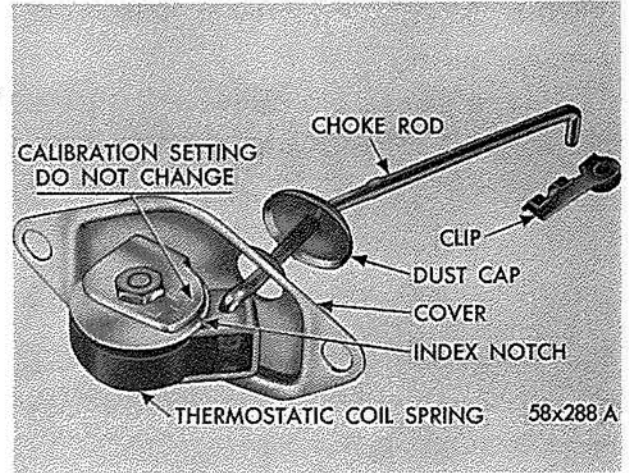

Fig. 12 Choke Control Unit (Cross-over)

- (3) The stop lugs on both the primary and secondary throttle levers should contact the bosses on the flange at the same time.
- (4) If an adjustment is necessary, bend the secondary throttle operating rod at the angle, using Tool T-109-213, until correct adjustment has been obtained.
- (5) At wide open throttle, the primary and secondary throttle valves should reach the full vertical position.
- (6) With the primary and secondary throttle valves in the tightly closed position, it should be possible to insert Tool T-109-29 (.020 inch) wire gauge, between the positive closing shoes on the secondary throttle levers, as shown in Figure 11.
- (7) If an adjustment is necessary, bend the shoe on the secondary throttle lever, using Tool T-109-22, until correct clearance has been obtained.

E. Secondary Throttle Lock-Out Adjustment

- (1) Open the throttle valves, then manually open and close the choke valve. The tang on the secondary throttle lever should freely engage in the notch of the lock-out dog.
- (2) If an adjustment is necessary, bend the tang on the secondary throttle lever, until engagement has been made. Use Tool T-109-22 for this operation.
- (3) After adjustments have been made, reinstall carburetor on engine, using a new gasket.
- (4) It is suggested that the carburetor bowl be filled with clean gasoline. This will help prevent dirt that is trapped in the fuel system from being dislodged by the free flow of fuel, as the carburetor is primed.

AUTOMATIC CHOKE (Well Type)

To function properly, it is important that all parts be clean and move freely. Other than the occasional cleaning, the automatic choke control requires no servicing. It is very important, however, that the choke control unit works freely at the thermostatic coil spring housing and at the choke shaft. Move the choke rod up and down to check for free movement of the coil housing on the pivot. If the unit binds, a new unit should be installed. The Well Type Choke Control Unit is serviced only as a complete unit. Do not attempt to repair (See Fig. 12).

Do not lubricate any parts of the choke or control unit since this causes dirt accumulation which would result in binding of the choke mechanism.

Do not attempt to change the calibration setting. (Refer to Specifications). This is pre-determined and should it be changed, improper choke action would result.

Clean all choke parts using a suitable solvent and then blow dry with compressed air. Examine all choke parts for wear or damage. Worn or damaged parts must be replaced with new parts in order to insure proper choke operation.

When installing the well type choke unit, make certain that the coil housing does not contact the sides of the wall in the intake manifold. Any contact at this point will affect choke operation.

The proper assembly sequence of the ram manifold choke to the intake manifold is as follows:

- (1) Gasket - choke coil well
- (2) Cup - choke coil well
- (3) Retainer - choke coil well
- (4) Assembly - choke coil housing and rod

IDLE SPEED ADJUSTMENT (CURB IDLE)

The idle speed adjustment is made after the carburetors have been installed on the engine.

(1) With the throttle valves closed and the choke valve wide open (engine at normal operating temperature), adjust the idle by-pass air-bleed screw at 725-750 rpm on AFB 2903S Ram Manifold Carburetors using a tachometer.

(2) Adjust the idle mixture screws until the engine operates smoothly, then recheck the tachometer and again adjust the idle by-pass air-bleed screws of both carburetors to give the correct engine rpm.

RAM INDUCTION MANIFOLD

The Ram Induction Manifold equipped engine, as shown in Figure 13, consists of twin air cleaners, twin AFB carburetors (with individual automatic well type chokes) and two aluminum manifolds, containing eight long sweeping passages (four in each manifold) all of which represent a new method of fuel induction.

The air-fuel mixture from each carburetor flows into a chamber directly under the carburetor, then passes through the long individual intake branches to the opposite cylinder bank. The right hand carburetor supplies air-fuel mixture for the left hand cylinder bank, whereas the left hand carburetor supplies the right hand cylinder bank. The passages between the right and left hand manifolds are inter-connected with a pressure equalizer tube.

The throttle linkage operates through a center mounted bell crank and controls both carburetors at the same time. It is very important that if one or more of the carburetors has been removed or either manifold, that a complete linkage adjustment be made in order to obtain peak engine performance. (Refer to Paragraph for "Setting the Ram Manifold Throttle Linkage").

SERVICE PROCEDURES

REMOVING THE RAM MANIFOLDS

Should it become necessary to remove either the right or left intake (or both) manifolds, refer to Figure 14.

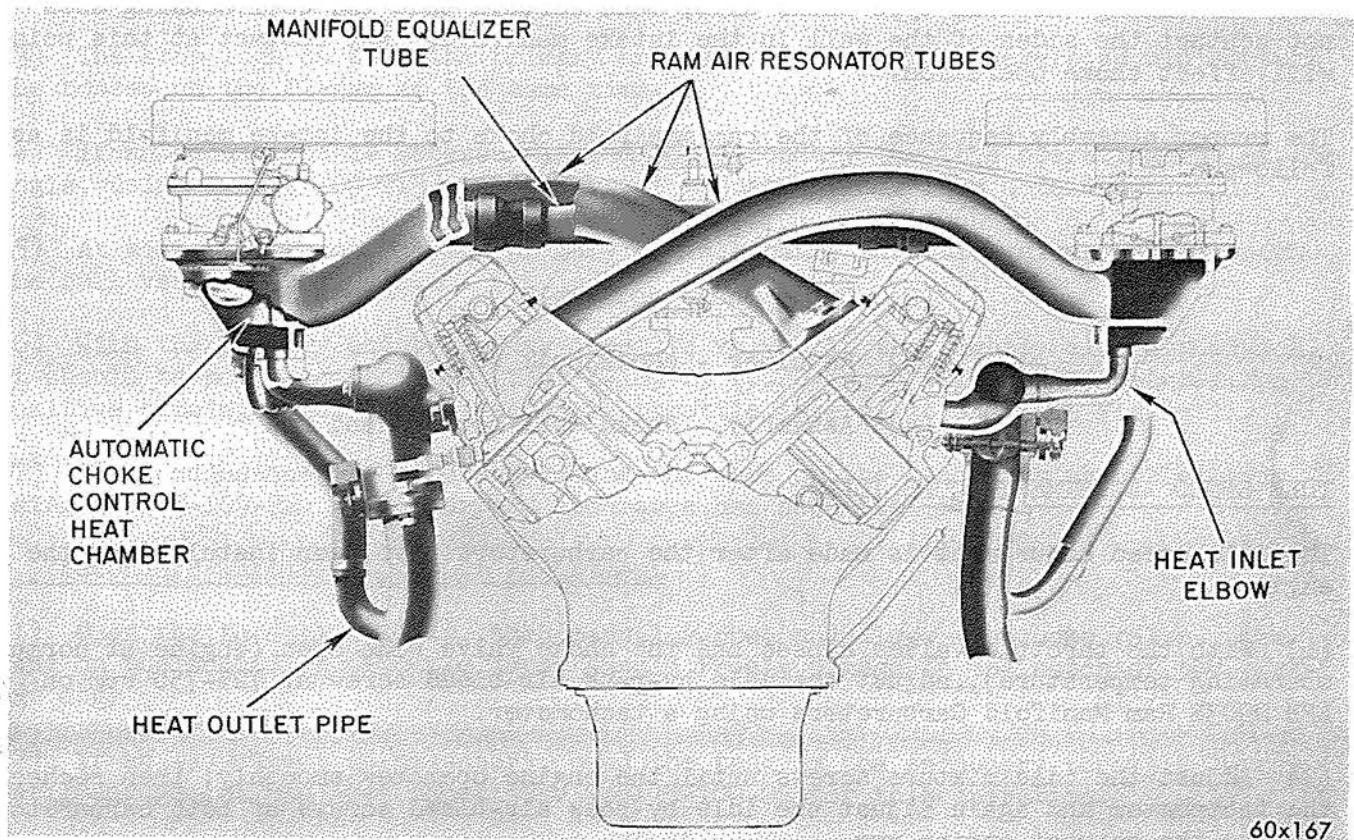
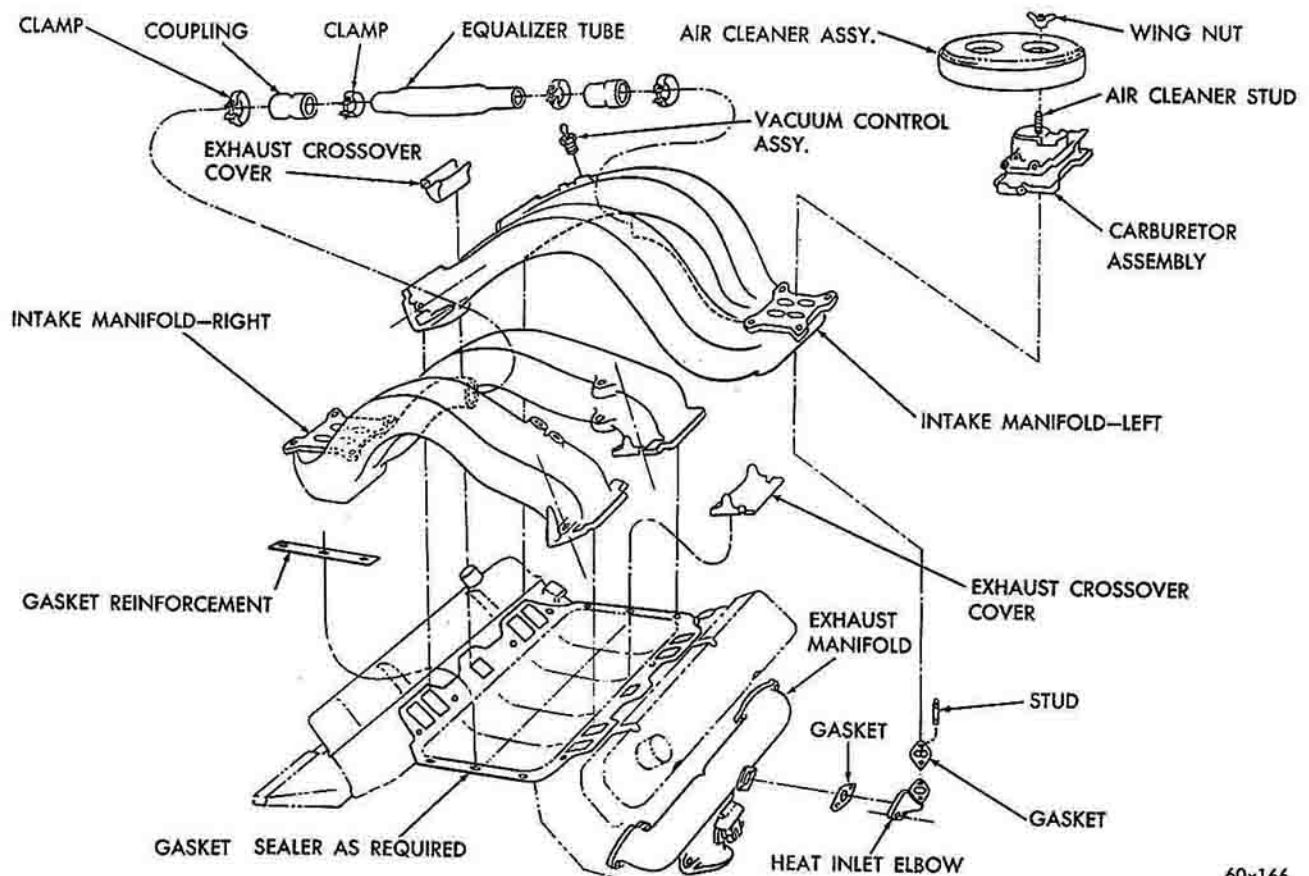

Fig. 13 Ram Manifold (Sectional View)

- (1) Drain the cooling system.
- (2) Remove the carburetor air cleaners.

- (3) Disconnect the fuel line between the fuel pump and the left hand carburetor.
- (4) Disconnect the fuel line between the left and right hand carburetor.
- (5) Disconnect the vacuum line between the right hand carburetor and the distributor. Disconnect the Anti-Stall device vacuum line.
- (6) Remove the high tension coil wire.
- (7) Disconnect the throttle linkage at both carburetors and the bellcrank, to the accelerator shaft.
- (8) Loosen the clamps that attach the equalizer tube couplings to the manifolds and the equalizer tube. Slide either coupling inward on the tube far enough to clear the manifold tube opening. Lift the equalizer tube, couplings and clamp up and away from engine.
- (9) Disconnect the power steering hoses at the pump and secure against the fire wall.
- (10) Remove the air conditioning compressor and brackets (if so equipped). Refer to Air Conditioning, in the 1960 Chrysler and Imperial Service Manual, Group 24.



60x166

Fig. 14 Ram Manifold (Exploded View)

Left Hand Manifold

- (11) Remove the eight attaching bolts that hold the left fender shield access plate to the fender shield, then slide the plate out of the engine compartment.
- (12) Remove the two bolts that attach the left hand by-pass pipe to the lower chamber.
- (13) Remove the two bolts that attach the left hand exhaust manifold elbow to the lower chamber. Discard the gaskets.
- (14) Remove the four bolts that attach the ram manifold to the right bank cylinder head. Remove the exhaust passage crossover cover.
- (15) Lift the ram manifold and carburetor from the engine as an assembly.
- (16) Remove the nuts that attach the carburetor to the intake manifold, then disconnect the automatic choke rod from the lever. Remove the carburetor.
- (17) Remove the two bolts that retain the automatic choke in the manifold. Lift choke assembly, gasket, reinforcement and well cup out of the manifold.

To remove the right hand ram manifold, proceed as follows:

- (18) Remove the eight attaching bolts that hold the right fender shield access plate to the fender shield, then slide the plate out of the engine compartment.
- (19) Remove the two bolts that attach the right hand exhaust bypass pipe to the lower chamber.
- (20) Remove the two bolts that attach the right hand exhaust manifold elbow to the lower chamber. Discard the gasket.
- (21) Remove the four bolts that attach the ram manifold to the left hand bank cylinder head. Remove the exhaust passage crossover cover.
- (22) Lift the ram manifold and carburetor from the engine as an assembly.
- (23) Remove the nuts that attach the carburetor to the intake manifold, then disconnect the automatic choke rod from the lever. Remove the carburetor.
- (24) Remove the two bolts that retain the automatic choke in the manifold, lift choke assembly, gasket, reinforcement and well cup out of the manifold.

With the manifolds removed, work can now be done on cylinder heads, tappets, etc.

INSTALLING THE RAM MANIFOLD

When installing the ram manifold, be sure and use new gaskets and be sure all mating surfaces are smooth and clean. Check to be sure that both manifold heat control valves are operating freely. If stuck or binding, free up, using heat control valve solvent.

To install the left hand ram intake manifold, refer to Figure 14.

(1) Place the automatic choke control unit in the reinforcement and well cup. Slide the assembly down into position in the intake manifold, using a new gasket. Install attaching bolts and tighten.

(2) Place the carburetor in position on the mounting pad of the intake manifold and engage the automatic choke control rod with the choke lever. Secure with clip. Install the carburetor mounting nuts and tighten.

(3) Place the intake manifold assembly in position on the right hand bank cylinder head. Place the exhaust crossover passage cover over the passage, then install the manifold attaching bolts finger tight.

(4) Slide a new gasket between the left hand exhaust manifold elbow and the lower chamber of the intake manifold. Install attaching bolts finger tight.

(5) Slide a new gasket between the left hand exhaust by-pass pipe and the manifold lower chamber. Install the attaching bolts and tighten to 10 foot-pounds torque. Tighten the elbow attaching bolts to 10 foot-pounds torque and the intake manifold bolts to 50 foot-pounds torque.

(6) Slide the left hand fender shield access plate into position against the fender shield. Install the bolts and tighten.

If both ram manifolds were removed, continue to install the right hand manifold as follows:

(7) Place the automatic choke control unit in the reinforcement and well cup, slide the assembly down into position in the intake manifold, using a new gasket. Install attaching bolts and tighten.

(8) Place the carburetor in position on the mounting pad of the intake manifold and engage the automatic choke control rod with the choke lever. Secure with clip. Install the carburetor mounting nuts and tighten.

(9) Place the intake manifold assembly in position on the left hand bank cylinder head. Place the exhaust crossover passage cover over the passage, then install the manifold attaching bolts finger tight.

(10) Slide a new gasket between the right hand exhaust manifold elbow and the lower chamber of the intake manifold. Install the attaching bolts finger tight.

(11) Slide a new gasket between the right hand exhaust by-pass pipe and the lower chamber. Install attaching bolts and tighten to 10 foot-pounds torque. Tighten the elbow attaching bolts to 10 foot-pounds torque and the intake manifold bolts to 50 foot-pounds torque.

(12) Slide the right hand fender shield access plate into position against the fender shield. Install bolts and tighten.

(13) Place the air conditioning compressor and brackets in position (if so equipped) and install the attaching bolts. Tighten securely. (Refer to the Air Conditioning Group 24 for method of recharging the system).

(14) Connect the Power Steering hoses to the pump. (Refer to Power Steering Group 19 for method of bleeding air out of the system).

(15) Slide the equalizer tube, clamps and couplings over the manifold tubes. Slide either coupling outward far enough to firmly engage the manifold. Tighten the clamps securely.

(16) Connect the throttle linkage at both carburetors and bellcrank to accelerator shaft.

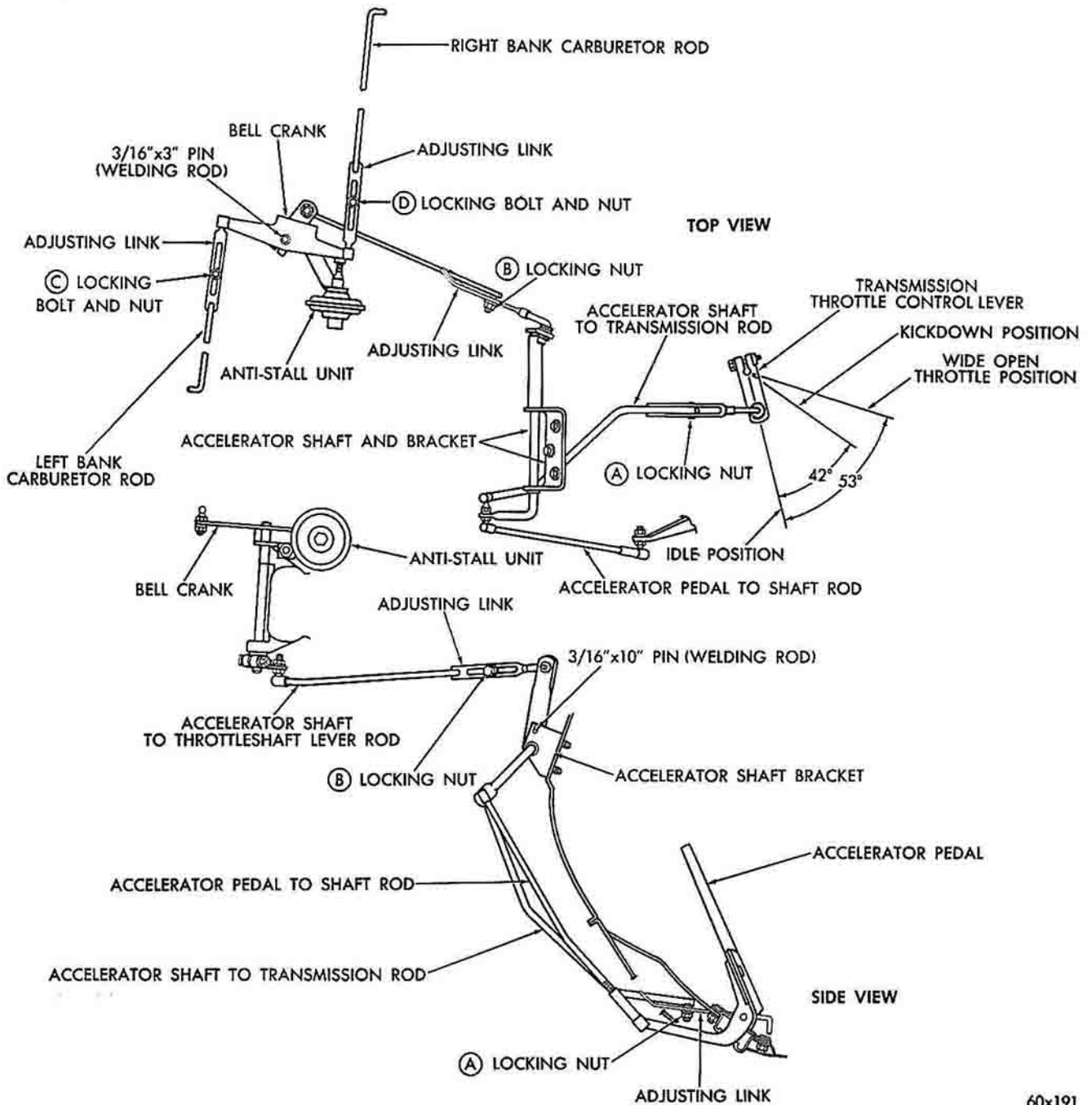

60x191

Fig. 15 Ram Manifold - Throttle Linkage (Schematic View)

(17) Install the high tension coil wire.

(18) Connect the vacuum line between the left hand carburetor and the distributor and the vacuum line to the anti-stall device.

- (19) Connect the fuel line between the left and right hand carburetor.
- (20) Connect the fuel line between the fuel pump and the left hand carburetor.
- (21) Install the right and left carburetor air cleaners.
- (22) Fill the cooling system to required capacity.

After the ram manifolds have been installed, it is very important that the setting of the throttle linkage be performed in order to obtain peak engine performance.

SETTING THE RAM MANIFOLD THROTTLE LINKAGE

Setting the throttle linkage is a very important step. If improperly set, various conditions affecting car performance can be encountered, such as loss of performance, no wide open throttle response, improper shifting of the transmission, no kickdown, delayed upshifts, etc.

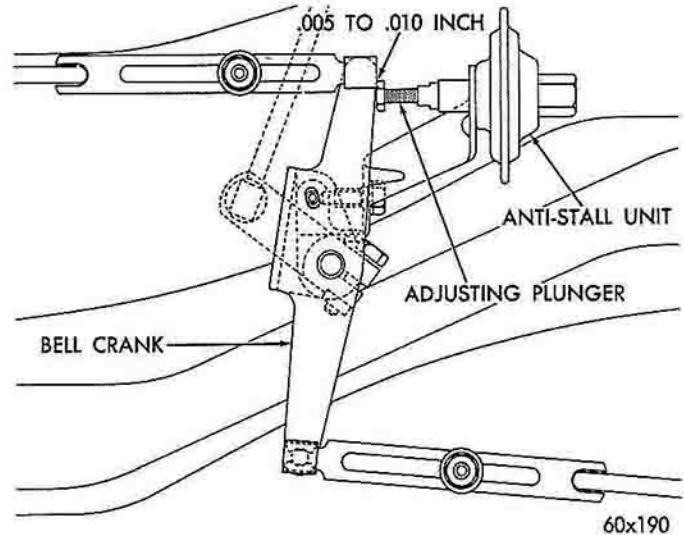

Fig. 16 Anti-Stall Adjustment

Setting the throttle linkage is divided into four parts:

1. Positioning the accelerator shaft.
2. Positioning the accelerator pedal.
3. Setting the bellcrank and synchronizing each carburetor.
4. Adjusting anti-stall device.

It is very important that the throttle linkage be set in this order. At any time the throttle linkage is reset, the anti-stall device must be reset.

A. Positioning the Accelerator Shaft (Fig. 15)

- (1) Loosen the adjusting nuts "A" and "B" (accelerator shaft to transmission rod and accelerator shaft to throttle shaft lever rod).
- (2) Insert a piece of 3/16 inch drill rod, 10 inches long into the accelerator shaft bracket and through hole in the lever.
- (3) Move the transmission throttle control lever forward until it stops. Tighten the locknut "A" securely. This positions the accelerator shaft.

B. Positioning the Accelerator Pedal

- (1) Unsnap the accelerator pedal to shaft rod.

(2) Turn the threaded end of the rod either in or out until a measurement of 114 degrees is obtained between the floor of the car and the flat face of the accelerator pedal.

NOTE: This measurement can be made with a protractor.

(3) After correct measurement has been obtained, reconnect the rod. Remove the drill rod from the accelerator shaft bracket.

C. Setting the Bellcrank (Fig. 15)

(1) Loosen locking nuts "C" and "D" (left and right bank carburetor rods).

(2) Back off the anti-stall adjusting plunger far enough to allow the bellcrank to be pivoted.

NOTE: Hold the anti-stall control push rod while adjusting set screw to prevent damage to the diaphragm.

(3) Pivot the bellcrank until a 3/16 inch piece of drill rod 3 inches long can be inserted through the bellcrank hole and down into the locating hole in the intake manifold.

(4) Inspect each carburetor to be sure the choke valves are open, that the fast idle cams are released, and that the throttle valves are in the closed position.

(5) Tighten locking nuts "C" and "D" securely. Remove the drill rod from bellcrank.

(6) Push rearward on the accelerator shaft to throttle shaft lever rod adjusting link, until stop is felt. Tighten the locking nut "B" securely.

(7) Depress accelerator pedal all the way to the floor and check primary and secondary throttle valves for WOT position.

ADJUSTING THE ANTI-STALL DEVICE

(1) To readjust the anti-stall device, it is necessary that the engine be at normal operating temperature and that the curb idle speed be 725 to 750 rpm and constant with the transmission in neutral (N) and the air conditioning compressor "ON" (if so equipped). (See next Paragraph "Adjusting the Ram Manifold AFB 2903S Series Carburetors" to obtain this idle speed).

(2) With the transmission in Drive (D) and with the parking brake and the foot brakes applied, turn the anti-stall plunger toward the bellcrank until clearance of .010" has been obtained. (Refer to Figure 16).

ADJUSTING THE RAM MANIFOLD AFB 2903S SERIES CARBURETOR

Two 4 barrel AFB 2903S series carburetors are used on the Ram Induction Manifold equipped cars. These carburetors are fundamentally the same as AFB 4 barrel carburetors used on the other 1960 models. The service procedures for disassembly, cleaning, inspection and reassembly follow the same sequence of operations as covered for the other AFB carburetors.

The following information covers only the adjustments that differ from conventional mounted carburetors.

A. Idle Speed and Mixture Adjustment (On the Vehicle)

Before the idle speed and mixture adjustments are made, inspect to be sure that the throttle linkage to both carburetors allows the return to the idle position simultaneously. This is very important in obtaining a good idle setting, since these carburetors are equipped with a bypass air bleed for setting the idle speed.

The Ignition timing should be checked to make certain it is within specifications, 5° BTC on the Chrysler Model C-300-F as this also affects idle quality. If the ignition timing is not within specifications, disconnect the vacuum advance line at the distributor as there is full vacuum advance at idle and set the timing with the engine idle speed below 600 rpm and transmission in neutral and air conditioning compressor "OFF" (if so equipped). If, under these conditions, idle speed is still above 600 rpm, adjust both carburetor idle by-pass air bleed screws equally until desired idle speed is obtained.

Connect the vacuum advance line and warm engine up to normal operation temperature. Disconnect each carburetor throttle rod at the bellcrank on the manifold, stop engine.

- (1) Turn all adjusting screws (mixture and by-pass) in finger tight.
- (2) Open the by-pass idle air bleed screws one full turn.
- (3) Open each idle mixture screw 3/4 turn.
- (4) Connect a tachometer, then start the engine.
- (5) Turn the mixture screws on the left carburetor 1/8 turn at a time until the smoothest idle has been obtained.
- (6) Repeat this procedure on the right carburetor, keeping the mixture screws within 1/8 turn of each other.
- (7) With the transmission in Neutral (N), air conditioning compressor "ON" (if so equipped) and parking brake applied, set the curb idle speed from 725 to 750 rpm by adjusting the by-pass air bleed screws on each carburetor. Be sure to keep the by-pass air bleed screw openings equal on both carburetors.
- (8) Repeat steps 5, 6 and 7 until a smooth idle at 725 to 750 rpm has been obtained.
- (9) Connect each carburetor throttle rod at the bellcrank.

If either carburetor has been removed for cleaning or repair, set the throttle linkage as outlined under Paragraph "Setting the Ram Manifold Throttle Linkage".

B. Fast Idle Adjustment (On Vehicle)

When making fast idle adjustment on the vehicle, each AFB carburetor should be adjusted individually. To make the fast idle adjustment, proceed as follows:

- (1) The engine should be at normal operating temperature and have a curb idle speed of 725 to 750 rpm with transmission in (N) and air conditioning compressor "ON" (if so equipped).
- (2) Turn air conditioning compressor "OFF" (if so equipped).
- (3) Remove each air cleaner.
- (4) Disconnect each throttle rod at the bellcrank on the intake manifold.
- (5) Open the throttle valves of the left carburetor far enough to allow positioning of the fast idle index mark. The right carburetor should remain at the curb idle position.
- (6) Adjust fast idle screw until a fast idle speed of 1375 to 1425 rpm is obtained on the Chrysler Model C-300-F.
- (7) After the desired engine speed has been obtained, open the throttle slightly to allow the fast idle cam to return to the open choke (or off fast idle) position.
- (8) Repeat steps, 5, 6 and 7 in setting the right carburetor fast idle speed as it is very important at the completion of this step (8), that each carburetor has identical fast idle speeds.

NOTE: There is no specification for engine rpm with both carburetors simultaneously set at the fast idle position.

- (9) Connect both carburetor throttle rods to the bellcrank.

C. Indexing the Choke Piston

Before indexing the choke piston, be sure the ignition system and timing are at the required specifications, that the manifold heat control valves are operating properly (this is very important for normal warm-up of the engine).

After the above items have been inspected and corrected index the choke piston as follows:

- (1) Remove the choke housing baffle plate.
- (2) Remove the throttle return spring, so that the throttle can be set at one quarter open.
- (3) Be sure the choke valve is wide open.
- (4) Slide a .026 inch wire into the choke piston slot, so that the hook on the end enters the slot in the cylinder, as shown in Figure 16. (This gauge can be made by bending the .026 inch end of wire gauge Tool T-109-189 to form the shape, as shown in Figure 16.

- (5) Push on the choke valve, counterclockwise, trapping the wire gauge between the piston and the cylinder slot (choke linkage hanging free).
- (6) It should now be possible to insert a No. 32 drill between the choke valve and wall of the air horn. If an adjustment is necessary, bend the link that connects the choke shaft to the choke piston lever (at angle) until the correct clearance has been obtained.
- (7) Place the choke baffle plate in position and install retaining screws. Tighten securely.
- (8) Connect the throttle return spring.

Group 16 - UNIVERSAL JOINTS AND PROPELLER SHAFT

The universal joint is of the same basic design as used in PC-3.

A heavier ribbed front universal joint dust cover boot is used to prevent boot collapsing due to higher speed.

The propeller shaft is a stepped shaft for tunnel clearance and is 3 1/4 inches in diameter.

For Service Procedures, refer to 1960 Chrysler and Imperial Service Manual.

Group 17 - SPRINGS AND SHOCK ABSORBERS

REAR SUSPENSION

The rear springs differ from the PC-3 in that they hold the car 1/2" lower in height and have a higher rate specification.

SHOCK ABSORBERS

The shock absorbers are of the heavy-duty type.

For servicing, refer to Group 17 of the 1960 Chrysler and Imperial Service Manual.

Group 19 - STEERING

The "Constant Control Full Time" Power Steering gear assemblies are of the same basic design as used on Model PC-3 except that the back pressure control valve assembly is inclined toward the front of the car to allow clearance between the return hose and the manifold. For servicing of the assemblies, refer to Group 19 of the 1960 Chrysler and Imperial Service Manual

Group 21 - TORQUEFLITE TRANSMISSION

SPECIFICATIONS

Type	Automatic Three Speed With Torque Converter
Torque Converter Diameter (inches)	12 1/2"

SPECIFICATIONS, (continued)

Oil Capacity of Transmission and Torque Converter 21 pts. Automatic Transmission
 Fluid Type "A" Suffix "A"
 Method of Cooling Water

GEAR RATIOS

1 - Low 2.45 to 1
 2 - Second 1.45 to 1
 D - Drive 1.00 to 1
 R - Reverse 2.20 to 1
 N - Neutral -----

FRONT - REAR PUMPS

Type Gear (Rotary)
 End Clearance (Front Pump)001 to .0025 inch
 End Clearance (Rear Pump)001 to .0025 inch
 Tip Clearance005 to .008 inch
 Outer Rotor Diametral Clearance008 inch Maximum

THRUST WASHERS

Input Shaft115 to .117 inch (Natural)
 .097 to .099 inch (Black)
 .078 to .080 inch (Red)
 .059 to .061 inch (Orange)
 Front Clutch and Sun Gear062 to .064 inch
 Output Shaft062 to .064 inch

SNAP RINGS

Kickdown Annulus Gear060 to .062 inch
 .064 to .066 inch
 Rear Clutch060 to .062 inch
 Low-Reverse Planet Pinion Carrier060 to .062 inch
 .064 to .066 inch
 .068 to .070 inch
 Front Clutch060 to .062 inch

Car Model	Engine (Cu, In.)	Kickdown Band (Back Off)	Front Clutch Cushion Spring	Accumulator Spring *	Rear Discs	Clutch Spring *	Governor (Type)	High Temp. Seals
PC3-300	413	2 1/2 turns	No	None	5	180	C(Ram)	Yes

* Lbs. Spring Tension

SERVICE INFORMATION

Torque-Flite Transmission - Ram Manifold Engines

The following information will acquaint the service technician with the procedures that differ from the standard Torque-Flite transmission and the one used on cars equipped with the ram manifold.

The disassembly, inspection, and assembly procedures are the same. There is a difference, however, in line pressure, governor, planet pinion carrier, and throttle linkage adjustment; they are as follows:

(1) The line pressure is increased from 90 to 105 psi (refer to Ram Manifold Line Pressure Chart). In order to compensate for this change a heavier regulator valve spring is used.

LINE PRESSURE CHART (Ram Manifold Cars Only)

Push Button Position	Rear Wheels	Engine Speed (RPM)	Line Pressure (PSI)
R	Free to Turn	1600	235 - 275
N	---	1200	100 - 110
D (Shifted into Direct	Free to Turn	1200	104 - 106
2	Free to Turn	1200	100 - 110
1	Free to Turn	1200	100 - 110
D	Free to Turn	3500	108 - 115

(2) Governor pressure is also changed. (Refer to Ram Manifold Governor Pressure Chart). In this case, the governor weight assembly incorporates a heavier spring along with a lighter outer weight.

GOVERNOR PRESSURE CHART (Ram Manifold Cars Only)

Push Button Position	Rear Wheels	C-300-F Car Speed	Governor Pressure
D	Free to Turn	21 - 24	15 psi
D	Free to Turn	36 - 43	50 psi
D	Free to Turn	55 - 62	75 psi

(3) Due to the increased torque provided by ram induction, the kickdown and reverse planet pinion carrier assemblies differ, they embody a planet pinion carrier that is made of a different aluminum alloy.

(4) The throttle linkage is designed to conform with the ram manifold equipped engine (Refer to Fig. 15).

It is very important that the throttle linkage be set in the following order:

Positioning the Accelerator Shaft

(1) Loosen the Adjusting nuts "A" and "B" (accelerator shaft to transmission rod and accelerator shaft to throttle shaft lever rod).

(2) Insert a piece of 3/16 inch drill rod, 10 inches long into the accelerator shaft bracket and through the hole in the lever.

(3) Move the transmission throttle control lever forward until it stops. Tighten the locknut "A" securely. This positions the accelerator shaft.

Positioning the Accelerator Pedal

- (1) Unsnap the accelerator pedal to shaft rod.
- (2) Turn the threaded end of rod either in or out until an angle of $11\frac{1}{4}$ degrees is obtained between the floor of car and the flat face of the accelerator pedal.
- (3) This angle can be obtained with a protractor.
- (4) After the correct angle has been obtained, connect the rod. Remove the locating pin from the accelerator shaft bracket.

Setting the Bellcrank

- (1) Inspect each carburetor to be sure the choke valves are open; that the fast idle cams are released and the throttle valves are closed.
- (2) Loosen the locking nuts "C" and "D" (left and right bank carburetor rods).
- (3) Back off the anti-stall adjusting plunger far enough to allow the bellcrank to be pivoted.
- (4) Pivot the bellcrank until a $\frac{3}{16}$ inch piece of drill rod 3 inches long can be inserted through the bellcrank hole and down into the intake manifold.
- (5) Tighten the locking nuts "C" and "D" securely. Remove the $\frac{3}{16}$ inch drill rod from the bellcrank.
- (6) Push rearward on the accelerator shaft to throttle shaft lever rod adjusting link, until the stop is reached. Tighten the locking nut securely.

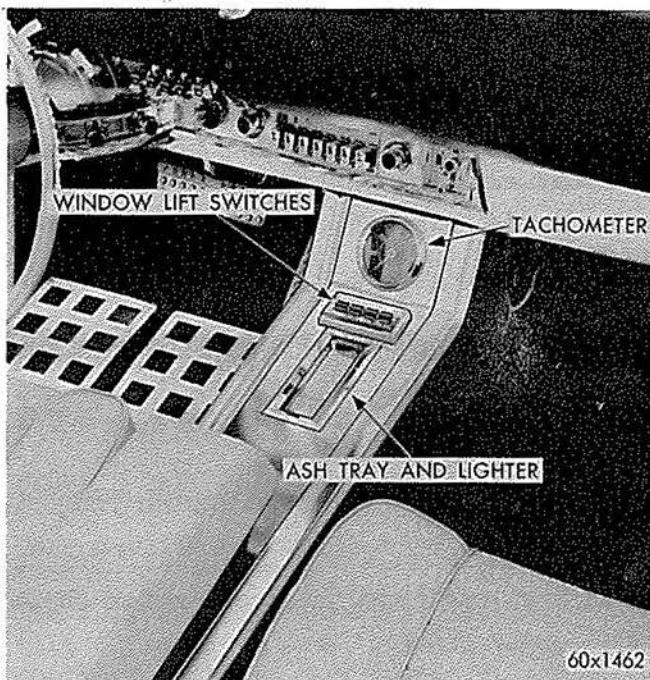

Fig. 17 Front Raised Instrument Control Console

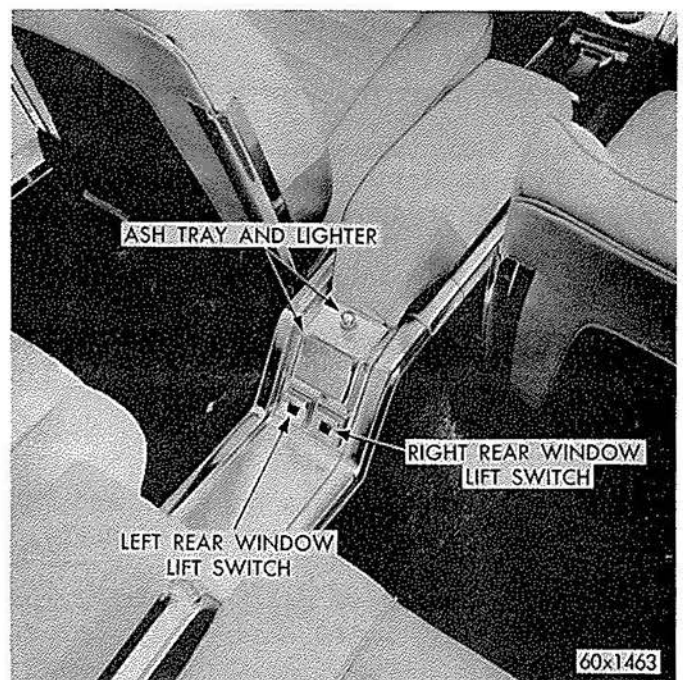

Fig. 18 Rear Raised Instrument Control Console

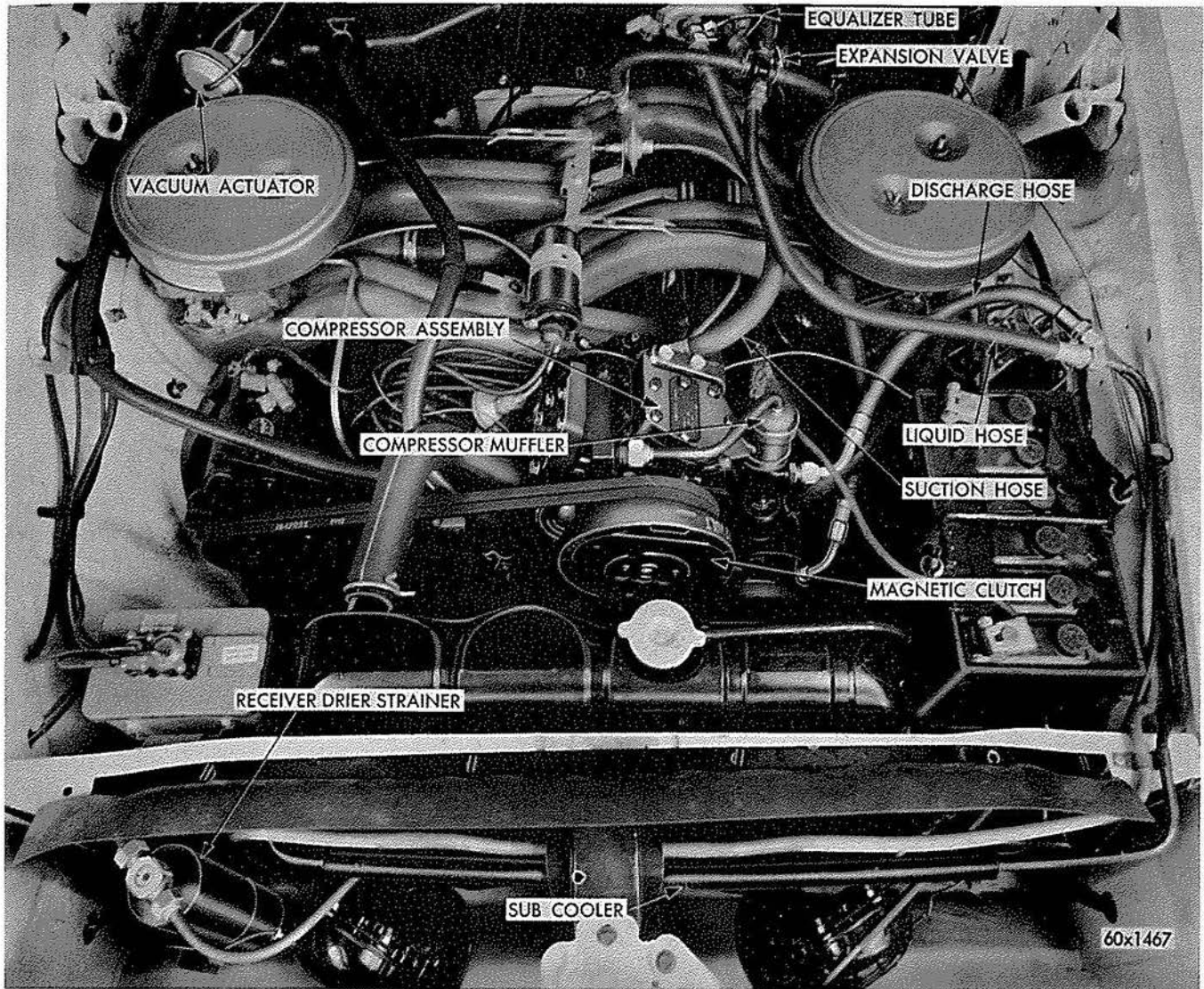

Fig. 19 Air Conditioning System Installed

Group 22 - WHEELS AND TIRES

The Hi-Speed Super Cushion Nylon Blue Streak tubeless tires (white - sidewall) (9.00 x 14) are standard equipment on the C-300-F.

For Service Procedures, refer to Group 22 in the 1960 Chrysler and Imperial Service Manual.

Group 23 - BODY AND SHEET METAL

The basic body to frame assemblies are similar to the PC-3 standard body. The hood panel, and radiator grille are entirely different from other Chrysler Models. The roof panel, windshield and rear glass, for the Special Club Coupe are the same as used on other Chrysler Special Club Models. The convertible windshield, folding top and rear curtain are the same as used on the PC-3 convertibles.

The door and quarter glass and panels are the same as used on the PC-3 Special Club coupe and convertibles, respectively, except that new chrome moulding attaching holes must be drilled in panels to correspond with the body trim mouldings, therefore, doors and quarter panels should be obtained without moulding holes. The rear deck lid has been modified with standard deck latch and lock assembly with special spare tire motif. Use deck lid less holes, and drill to suit.

Swivel seats are standard equipment on the Chrysler 300-F. Separating the four seats down the center of the car is a raised instrument control console extending from the instrument panel all the way to the back of the rear seats, as shown in Figures 17 and 18. The tachometer, front window lifts and ash tray and lighter, are shown in the middle of the front seats, and the ash tray and lighter, are shown in the middle of the rear seats, with both window lift switches. Installation, removal and servicing of body components are similar to the procedures in the 1960 Chrysler and Imperial Service Manual.

Group 24 - AIR CONDITIONING

Air Conditioning on first production cars was the same as PC-3, and on cars after production, the air conditioning suction and liquid lines were rerouted plus an additional tube added for expansion valve to the evaporator unit, due to the ram manifold engine. (See Fig. 19).

Service Procedures will remain the same as outlined in the 1960 Chrysler and Imperial Service Manual.